

STREETFIGHTER V2



Index

5	A New Fighter in Town	21	Electronics Latest generation electronics
6	Brave the Storm	24	Servicing and maintenance
8	Powerful and enjoyable performance on the road	27	Technical data and equipment
12	Design A unique and distinctive personality	32	Apparel
17	Ergonomics Designed not to tire	38	Accessories Configure the Ducati of your dreams.
18	Chassis Balancing sportiness and comfort	42	Ducati Digital Experience



A New Fighter in Town

The Streetfighter V2 is a sports naked with a one-of-a-kind character, designed for those seeking a bike that can combine the sporty DNA of the Panigale V2 with the attitude and style of the Streetfighter. The result is an intuitive and easy-to-handle vehicle, with the right dose of power to ensure feisty performance and maximum riding enjoyment.

This bike is a reinterpretation of Ducati's successful "Fight Formula" applied to the Panigale V2, which is stripped of the fairings and equipped with a high and wide handlebar. It has a dry weight of 178 kg and is powered by the 153 hp 955 cc Superquadro engine, controlled by a latest-generation electronics package





Brave the storm

The Streetfighter V2 range includes the Ducati Red colour scheme and with MY23 it is expanded with the introduction of a new matt metallic green colour that enhances the bike's design: Storm Green.



ENGINE

Powerful and enjoyable performance on the road



Powerful but enjoyable on the road, the 955 cc Superquadro twin of the Streetfighter V2 can achieve 153 hp at 10,750 rpm and maximum torque of 101.4 Nm at 9000 rpm. Euro 5-approved, the Streetfighter V2 engine shares an exhaust with the Panigale V2, the system entirely developed beneath the engine. A compact silencer emerges on the right side, while the throttle bodies

(controlled independently with a full Ride by Wire system) are oval cut with a diameter of 62 mm.

True of all Ducati sports bikes, the engine of the Streetfighter V2 is also a structural element of the chassis. The cylinder banks form a 90° 'V', as is Ducati tradition but the cylinders are rotated backwards to obtain a 21° angle

between the front cylinder and the horizontal plane, so as to minimise the bike's wheelbase.





This 955cc twin boasts a bore and stroke of 100 and 60.8 mm respectively, figures that make for a Superquadro, or rather a short-stroke engine. A technical decision made in order to ensure efficient fluid dynamics (the intake valve measuring a significant 41.8 mm, the exhaust valve 34 mm) as well as real rideability and smooth delivery.

The valve-control technology is also a standout Ducati feature, the Desmodromic system with sport-derived rocker arms coated in DLC (Diamond-like Carbon) serving to reduce friction and increase fatigue resistance. This does not just allow for more consistent performance, but also reliability over time and distance.

The transmission of the Streetfighter V2 is entrusted to a 6-speed gearbox with Ducati Quick Shift Up / Down EVO 2 system. With respect to the Panigale V2, the Streetfighter V2 has a shorter final ratio (15/45 compared to 15/43 on the Panigale V2), which guarantees greater torque to the wheel at road-going speeds, for a better engine response when reopening the throttle.

The wet clutch is equipped with an anti-hopping and progressive servo system that allows limited slippage when braking torque is applied. This means better control of the bike during braking and an increase in the load on the discs during acceleration without compromising the effort on the lever.

DESIGN

A unique and distinctive personality

The Streetfighter V2 knows exactly how to stand out. That is thanks to its design that shows at the first glance a strong family feeling with the muscular Streetfighter V4, a model from which it inherits the most characteristic elements. However, the Ducati Centro Stile has worked on the reinterpretation of some aesthetic concepts, with the ultimate goal of providing the bike with a strong and distinctive character, by means of a series of changes that underline its unique attitude.

The Streetfighter V2 style is shaped around the mechanics inherited from the Panigale V2, with the Superquadro engine as a bearing element.

The two main lines naturally connect the tail to the front fairing through the engine and the tip. All this, works in harmony with the superstructural elements and thus reflecting the idea

of a particularly elegant, agile and compact motorcycle. The end result is a sports naked unique features, able to create a new market segment. The true spirit of the Streetfighter V4 is perfectly represented by the minimalistic design and characterized by the distinctive headlight, which recalls the Panigale V4 front, including the V-shaped DLR*, and the famous grin of the Joker. Moreover, the headlight is part of the double-layer fairing that integrates the air intakes.



The front light unit features an extremely compact headlight, thanks to the adoption of two dual-function LED modules for low beam and high beam. The Daytime Running Light and the upper thread of the double headlamp make for a frowning look, the modern hallmark of Ducati sports bikes. At the rear, the full LED light is functionally divided into two parts, in line with Ducati sports bike tradition. In case of any violent braking, the Ducati Brake Light (DBL) system automatically activates a flashing of the rear light, signalling the sudden deceleration to any vehicles following behind and contributing to the active safety of the vehicle. The double red arc of the positioning light ensures the Streetfighter V2 is unmistakable, as does its aggressive expression. Rounding out the lighting system are LED front and rear turn signals*.

* Bike specifications and equipment may vary from market to market.

Please refer to your local dealer for further information





ERGONOMICS

Designed not to tire

The ergonomics of the Streetfighter V2 centre around the rider and are focused on road use, while also ensuring sportiness and comfort. The high and wide aluminium handlebars replace the handlebar risers of the Panigale V2. The saddle is now wider and has new padding that contributes to making this bike even more comfortable. In addition, the footpegs have been repositioned to increase the amount of room. All these improvements allow the rider real control during sports riding while also facilitating everyday use.

The suspension on the Streetfighter V2 also contributes to the level of comfort, offering all the support required when tackling challenging twists and turns, but also able to adapt to everyday use.

CHASSIS

Balancing sportiness and comfort

In developing this model, the engineers focused particularly on the chassis. The Superquadro engine is used as a load-bearing element connecting the compact front structure, which comprises a cast aluminium monocoque frame fixed to the engine head. The single-sided swingarm, also connected to the engine, is 16 mm longer compared to that of the Panigale V2, a standout solution that helps ensure the stability of the whole bike.

Added to this is the 43 mm Showa BPF front fork and the Sachs shock with dedicated calibration to make this bike more comfortable on the road but also easy to set-up for the track. The equipment is completed with a Sachs steering damper. The Streetfighter V2 is equipped with

five-spoke wheels and the new Pirelli Diablo Rosso IV tyres, size 120/70 ZR17 at the front and 180/60 ZR17 at the rear, which provide an ultra-quick response to the rider's needs and added cornering feeling. The braking system is the same as that of the Panigale V2, with Brembo M4-32 monobloc callipers and 320 mm discs, though the brake pads have a less aggressive bite, which makes them more suitable for road use.





ELECTRONICS

Latest generation electronics

The Streetfighter V2 is equipped with the IMU inertial platform which oversees all the electronic controls, including Cornering ABS EVO, Ducati Traction Control (DTC) EVO 2, Ducati Wheelie Control (DWC) EVO, Ducati Quick Shift up/down (DQS) EVO 2, and Engine Brake Control (EBC) EVO.

The operating parameters of each control are associated by default with the three Riding Modes, which undergo a name change with respect to those of the Panigale V2 and see the introduction of the Wet Riding Mode with specific Traction Control and Wheelie Control settings for low grip surfaces.

The Riding Modes are also associated with three Power Modes: High, with a full torque curve, Medium with a gentler torque curve, and Low, with limited power. In addition, and for the first time, the Superquadro engine presents dedicated torque mapping for the Medium and Low Power Modes for more linear delivery during road use.

The ABS with cornering function, adjustable according to three levels, stops the wheel from locking even when the bike is tilted, thus preventing a low side crash.

The MotoGP-derived DTC EVO2 traction control allows the rider to adapt the intervention level to the lean angle and offers strategies designed to allow maximum performance on track as well as maximum safety on the road.

The Ducati Wheelie Control (DWC) EVO manages any wheelieing while maximising acceleration easily and safely.

The DQS EVO 2 exploits lean angle data to maximise bike stability when shifting gears through the corners, while the EBC (Engine Brake Control) helps the rider to optimise bike stability in extreme turn-in conditions.

Instrumentation on the Streetfighter V2 comprises a 4.3" TFT display complete with particularly intuitive interface and graphics, which facilitate menu navigation and make it easy to adjust the settings, as well as allowing for immediate identification of the selected Riding Mode.

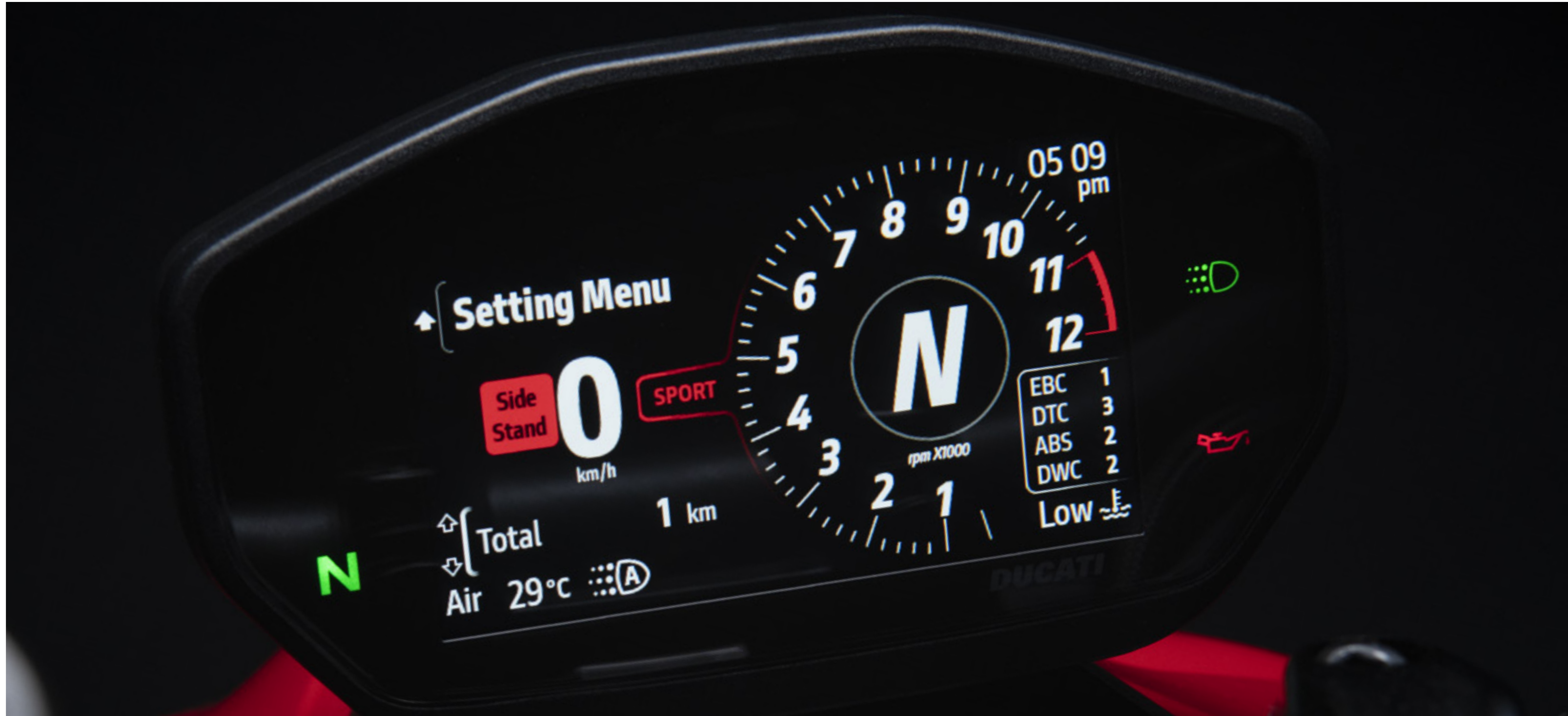

The Riding Mode adjustment interface immediately displays just how the settings are being changed with readable graphics and a graduated scale that indicates whether the modification relates more to vehicle performance or stability.

The Streetfighter V2 is suitable for use with the Ducati Multimedia System (DMS), via which the rider can receive calls, select and listen to music, and receive text message notifications with the aid of Bluetooth technology.

Servicing and maintenance

Safety as standard

The continuous work that Ducati carries out in terms of design, research and development has the specific aim of ensuring bikes are always cutting-edge and offer the ultimate level of active safety. A commitment that means defining increasingly advanced systems that heighten the level of rider control during the most delicate riding phases.

The Streetfighter V2 features Cornering ABS EVO complete with slide by brake function, Ducati Traction Control (DTC) EVO 2, Ducati Wheelie Control (DWC) EVO, Ducati Quick Shift up/down (DQS) EVO 2, and Engine Brake Control (EBC) EVO.

More value to your passion

With Ever Red, the quality and reliability of the Ducati brand remain your inseparable travelling companions over time. Ever Red is the exclusive Ducati warranty extension programme. With its activation you can continue to feel protected for 12 or 24 months beyond the expiration of the Ducati Warranty (24 months). Ever Red includes roadside assistance for the entire coverage period and no mileage limits. In this way you can ride for all the kilometres you want, even abroad, enjoying your Ducati without any worries.

To find out if the Ever Red extension is available in your country and for further information contact your Ducati dealer or visit ducati.com.

Endless excitement

In designing each bike, Ducati always sets itself the goal of ensuring maximum reliability while reducing maintenance costs. A commitment that has seen it extend the main service interval to 60,000 km (36,000 miles), during which a valve clearance check and registration is carried out as required. Even the simplest operations, like the Oil Service, are now scheduled at 15,000 km (9,000 miles) or 24 months.

An interval that is unbeatable in the two-wheeled world and that only confirms the very high quality standards Ducati applies to its material selection and R&D processes. Ducati continuously invests in the technical training of its dealers. The specific knowledge of official Ducati Service network members means that all operations needed to keep every Ducati in perfect working order are meticulously carried out. Advanced equipment such as the Ducati Diagnosis System ensures every Ducati will always have the latest software updates so that the electronic systems continue to perform at the highest level.

Always by your side

One of Ducati's main goals is to offer every Ducatista the chance to enjoy unlimited and safe travel all over the world. To achieve this aim, Ducati offers a "fast delivery" original spares service, with delivery in 24/48 hours across 85% of the areas in which it operates. With a distribution network that covers more than 92 countries, thanks to 790 official Dealers and Service Points*, choosing a Ducati means you can travel worry free and in total freedom, wherever the road may take you, and count on support from our extensive Dealer network that ensures Ducati quality and professionalism is always close at hand.

790 Authorised dealers and service points

92 World countries

*Information updated as of February 2022



Ever Red
Extended Warranty



*Equal to 15,000 miles.





Technical data and equipment

STREETFIGHTER V2

Dimensions

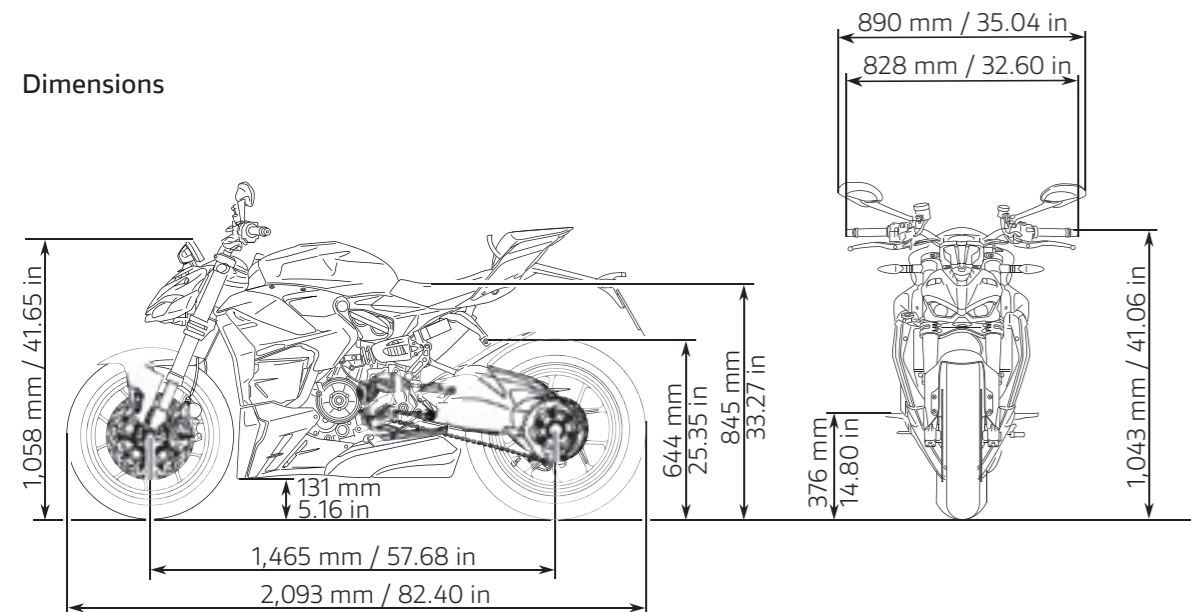

Power and torque

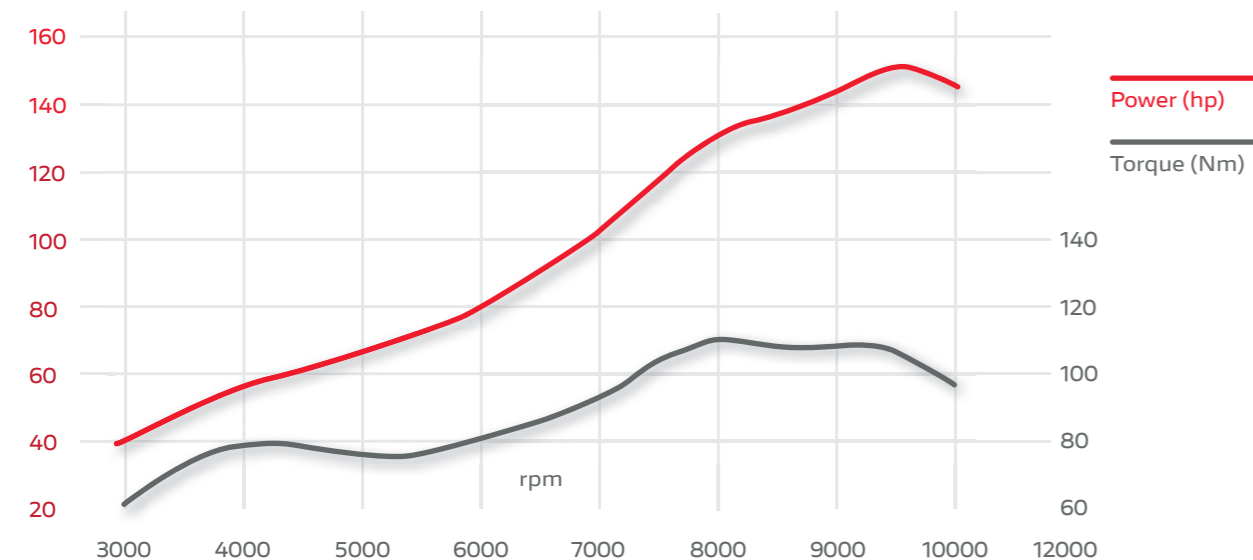

Engine

Engine	Superquadro: 90 ° V2, Desmodromic 4 valves per cylinder, liquid cooled
Displacement	955 cc
Bore X Stroke	100 x 60.8 mm
Compression ratio	12.5:1
Power	112.3 kW (153 hp) @ 10.750 rpm
Torque	101.4 Nm (74.8 lb-ft) @ 9.000 rpm
Fuel injection	Electronic fuel injection system. Twin injectors per cylinder. Full ride-by-wire elliptical throttle bodies
Exhaust	2-1-2-1 system, with 2 catalytic converters and 2 lambda probes

Transmission

Gearbox	6 speed with Ducati Quick Shift (DQS) up/down EVO 2
Primary drive	Straight cut gears; Ratio 1.77:1
Ratio	1=37/15 2=30/16 3=27/18 4=25/20 5=24/22 6=23/24
Final drive	Chain; Front sprocket 15; Rear sprocket 45
Clutch	Hydraulically controlled slipper and self-servo wet multiplate clutch. Self bleeding master cylinder

Chassis

Frame	Monocoque Aluminium
-------	---------------------

Front suspension	Fully adjustable Showa BPF fork. 43 mm chromed inner tubes
------------------	--

Front wheel	5-spokes light alloy 3.50" x 17"
-------------	----------------------------------

Front tyre	Pirelli Diablo Rosso IV 120/70 ZR17M
------------	--------------------------------------

Rear Suspension	Fully adjustable Sachs unit. Aluminum single-sided swingarm
-----------------	---

Rear wheel	5-spokes light alloy 5.50" x 17"
------------	----------------------------------

Rear tyre	Pirelli Diablo Rosso IV 180/60 ZR17M
-----------	--------------------------------------

Wheel travel (front/rear)	120 mm (4.72 in) - 130 mm (5.12 in)
---------------------------	-------------------------------------

Front brake	2 x 320 mm semi-floating discs, radially mounted Brembo Monobloc M4.32 4-piston callipers with Bosch Cornering ABS EVO. Self bleeding master cylinder
-------------	---

Rear brake	245 mm disc, 2-piston calliper with Bosch Cornering ABS EVO
------------	---

Instrumentation	Digital unit with 4,3" TFT colour display
-----------------	---

Dimensions and Weights

Dry weight	178 kg (392 lb)
Kerb weight	200 kg (441 lb)
Seat height	845 mm (33,3 in)

Wheelbase	1,465 mm (57.7 in)
-----------	--------------------

Rake	24°
------	-----

Trail	94 mm (3.70 in)
-------	-----------------

Fuel tank capacity	17 l - 4.5 gallon (US)
--------------------	------------------------

Number of seats	Dual seat
-----------------	-----------

Safety equipment

Riding Modes, Power Modes, Bosch Cornering ABS EVO, Ducati Traction Control (DTC) EVO 2, Ducati Wheelie Control (DWC) EVO, Engine Brake Control (EBC) EVO, Auto tyre calibration

Standard equipment

Ducati Quick Shift (DQS) up/down EVO 2, Full LED lighting with Daytime Running Light (DRL*), Sachs steering damper, Auto-off indicators

Ready for

Ducati Data Analyser+ (DDA+) with GPS module, Ducati Multimedia System (DMS**), Ducati LinkApp, Anti-theft

Warranty and Maintenance

Warranty	24 months unlimited mileage
----------	-----------------------------

Maintenance	12,000 km (7,500 mi) / 12 months
-------------	----------------------------------

Valve clearance check	24,000 km (15,000 mi)
-----------------------	-----------------------

Emissions and Consumption***

Standard	Euro 5
----------	--------

CO ₂ emissions	139 g/km
---------------------------	----------

Consumption	6 l/100 km
-------------	------------



Equal to 14,000 miles.

Indication of mileage at the first Desmo Service, or rather the first service during which valve clearance is checked and adjusted if necessary.

*Bike specifications and equipment may vary from market to market. Please refer to your local dealer for further information

** These systems are accessories. The availability of the services may vary depending on the country, smartphone model and operating system version.

*** Only for countries where Euro 5 standard applies

STREETFIGHTER V2

Ducati Red



Storm Green



Apparel

Speed Evo
Full-face helmet

Black Rider
Leather jacket

Company C3
Jeans

Downtown C1
Technical short boots



Ducati Apparel Collection designed by *Drudi Performance*





Speed Evo C2
Leather jacket

Company C3
Leather trousers

Speed Evo C1 WP
Sport-touring boots





Speed Evo
Full-face helmet

Ducati Corse C5
Leather gloves

Ducati Corse D-air® C2
Racing suit with airbag system

Ducati Corse V5 Air
Racing Boots

ACCESSORIES

Configure the Ducati of your dreams.

Streetfighter V2 means optimum Ducati technology, performance, and comfort. To enjoy adventures and journeys of any distance, in all conditions and on any road.

Configure

Choose the ideal Streetfighter V2 for you and have fun configuring it to suit your riding style!

Share your Streetfighter V2 with friends and send it to your Ducati dealer who will contact you for an online consultation to discuss the current offers that best suit your needs.

Save your configuration to return to it at any time.

Calculate your payment

Ducati Financial Services offers favourable solutions for the financing of every model in the Ducati range.

Personalise your financing and calculate the monthly instalments. You can then contact your dealer and discuss the best way to see your dream come true!



Go to configurator

For more information about the Ducati Performance range, tech specs and instructions, refer to a Ducati dealer or visit the Accessories section of ducati.com



1



2



3



4



5



6

2 Carbon front mudguard.
Set of carbon wings.



2 Clutch fluid reservoir.



3 Carbon rear mudguard.



4 Billet aluminium handlebar balancing weights.



5 Carbon heel guard.







6 Titanium racing silencers





Ducati Digital Experience

A mission for every channel. Continuous updating on the innovation and passion for which our work stands out. We transform emotions into exclusive content. Just a click away.

Follow us on:

-  www.ducati.com
-  [@ducati](#)
-  [@DucatiMotor](#)
-  [Ducati Motor Holding](#)

-  [@ducati](#)
-  [Ducati Motor Holding](#)
-  [@ducati_official](#)

MyDucati App

MyDucati is the personal area for every Ducatista, offering a wide range of services accessible with a single login from both the web and the app. Explore all the features of the MyDucati world and enjoy a multi-channel, customised experience wherever you are.

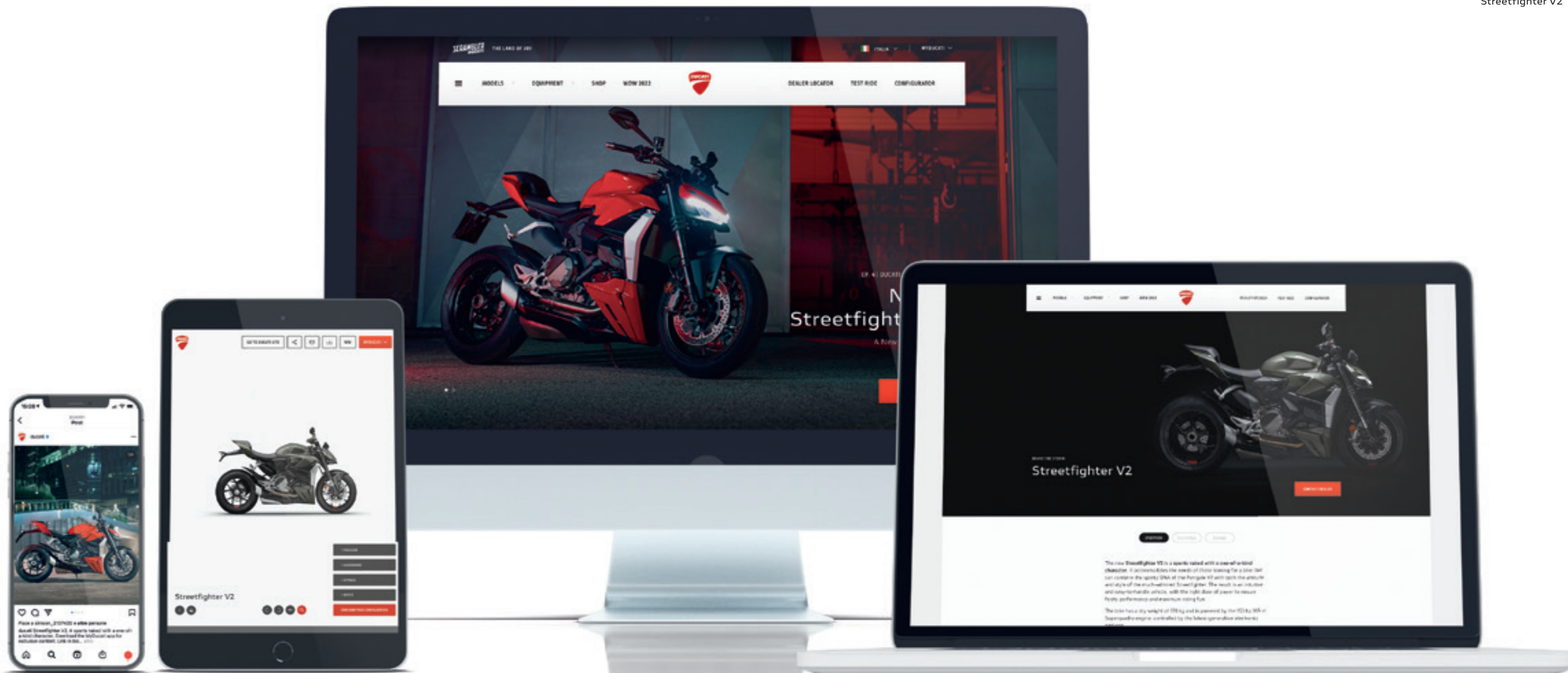

Key to symbols

 This product is designed exclusively for race bikes ridden on a closed racetrack. Its use on public roads is forbidden by law.

 This accessory is not approved for road circulation.

 Solo uso pista. Il prodotto contraddistinto da questo simbolo può essere utilizzato esclusivamente su veicoli da competizione. La legge vieta l'utilizzo della moto con questo prodotto installato al di fuori dei circuiti. Verificare con il singolo circuito l'esistenza di eventuali ulteriori limitazioni. Le moto con questo accessorio montato non possono essere utilizzate su strada.

 Anodized

 Matt

 Red

 Black



Riding a motorcycle is the most exciting way to enjoy the road, and offering the utmost safety to the motorcyclist is Ducati's commitment. Ducati bikes are increasingly easy to handle, reliable and better equipped to guarantee maximum safety and enhance riding pleasure. Technical clothing is made with more and more advanced materials for adequate protection and increased visibility. The safety of motorcyclists is Ducati's commitment. For more information visit the safety section of the Ducati site (www.ducati.com).

Warning: The photos and technical information in this catalogue may refer to prototypes subject to modifications during production and are purely for illustration and reference purposes, and are therefore not binding on Ducati Motor Holding S.p.A. Sole Shareholder Company - Company subject to the direction and coordination of AUDI AG ("Ducati"). Ducati cannot be held responsible for any print and/or translation errors. This catalogue is transnational and therefore some products may not be available and/or their features may vary in accordance with local laws. Not all colours and versions are available in each country. Ducati reserves the right to make changes and improvements to any product without obligation of prior notice or to make such changes to products already sold. Further characteristics of the products are contained in the pertinent owner's manuals. The

products represented are not definitive versions and are therefore subject to significant changes at Ducati's discretion without prior notice. The photographs published in this catalogue show only professional riders under controlled street conditions. Do not attempt to imitate such riding behaviour as it could be dangerous for you or other people on the road. This catalogue, including but not limited to the trademarks, logos, texts, images, graphics and table of contents herein, constitute Ducati intellectual property, or in any event Ducati has the right to reproduce it; any reproduction, modification or other whole or partial use of the catalogue or its contents, including publication on the Internet without the prior written consent of Ducati, is prohibited.

Actual fuel consumption may vary based on many factors, including but not limited to riding style, maintenance performed, weather conditions, surface characteristics, tyre pressure, load, weight of the rider and the passenger, accessories.

Ducati indicates the dry weight of the motorcycle excluding battery, lubricants and coolants for liquid-cooled models. The weights in running order are considered with all operating fluids, standard equipment and the fuel tank filled to 90% of its useful capacity (UE regulation no. 168/2013). For more information visit www.ducati.com.

August 2022



ducati.com

